

SOLID STATE RELAY (SSR) PRINCIPLES

A - General	page 2
B - Constitution of a solid state relay	page 2
1- Input circuit	page 2
2- Adaptation circuit	page 3
2-1 - Zero cross control	page 3
2-2 - Instantaneous control	page 3
2-3 - Peak voltage control	page 3
2-4 - Control for upgraded solid state relays	page 3
3- Power switching component	page 3
3-1 - Types et caractéristiques	page 3
3-2 - Thermal	page 4
3-2-1 Voltage drop at on state	page 4
3-2-2 Cooling and choice of heatsink	page 4
a) reminder of ohm's law	page 4
b) Modules without heatsinks	page 5
c) Relays with base plate	page 5
c-1 : Determination by calculation	page 5
c-2 : Using the thermal curves	page 5
d) Mounting without heatsink on backplate	page 6
e) Mounting several relays on the same backplate	page 6
f) Using ready-to-use relays	page 7
g) Precautions for mounting	page 7
4- Protection circuit	page 7
4-1 Protection by RC network	page 7
4-2 Protection by VDR	page 7
C — Other important characteristics	page 8
1- Peak voltage	page 8
2- Insulation	page 8
3- Leakage current	page 8
4- Nominal current	page 8
5- Surge current	page 9
6- Merging integral or I ² t	page 9
7- Protecting solid state relays from short-circuits of the load	page 9
7-1 Protection by fuses	page 10
7-2 Protection by circuit-breaker	page 10
7-3 Choice of circuit-breaker	page 10
D — Special relays	page 11
1- Relays for direct current	page 11
2- Interface modules	page 12
3- Upgraded relays	page 12
4- Special and power electronic relays	page 12
E — Reliability and conformity	page 12
1- Technology (DCB)	page 12
2- Tests	page 12
3- Lifetime and MTBF	page 13
4- Standards and "CE" marking	page 14
5- Specific point on EMC	page 15
5-1 Main EMC standards adapted to solid state relays	page 16
5-1-1 Immunity	page 16
a) EN61000-4-2 and EN61000-4-3	page 17
b) EN61000-4-4 and EN61000-4-5	page 18
5-1-2 Emission	page 18

Proud to serve you

celduc[®]

r e l a i s

All technical characteristics are subject to change without previous notice.
Caractéristiques sujettes à modifications sans préavis.

A-GENERAL

Solid state relays are switching devices made from electronic components. The term "Relay" is used as in electromechanical relays which are separated galvanically from the control circuit and switched circuit and "solid state" confirming that there are no moving parts.

Thanks to electronics, these relays have three essential characteristics :

- Amplification : very low control power directly adapted in terms of voltage and current with the logic outputs of electronic systems, giving rise to an extremely simplified control circuit with no relay coils that always tend to generate "interference".
- Rapidity and the possibility of choosing the switching moment : zero cross tripping on resistive loads (or another mode of control suited to the load) and zero-current switching preventing sharp instantaneous variations of interference-generating current. This is an essential factor with the new European directives pertaining to electromagnetic compatibility (EMC) both in terms of conducted and radiated disturbances.
- No moving parts giving rise to a practically unlimited operating life, no arcs (explosion-proof), fully moulded therefore ideal for polluted atmospheres (dust, gas, etc), noiseless, resistant to shocks and vibrations.

Alternatively, electronic relays must be suitably cooled since the voltages and currents must not exceed the values specified and the output in blocked state has a minimum leakage current.

celduc manufactures an extensive range of solid state power relays up to 125 Amperes, single or three phase, input/output interface modules and a range of upgraded solid state relays designed for improved control of certain loads when it comes to power, speed, starting or rotation direction control.

B- CONSTITUTION DES RELAIS STATIQUES .

A solid state relay is made up of 4 major parts (figure 1)

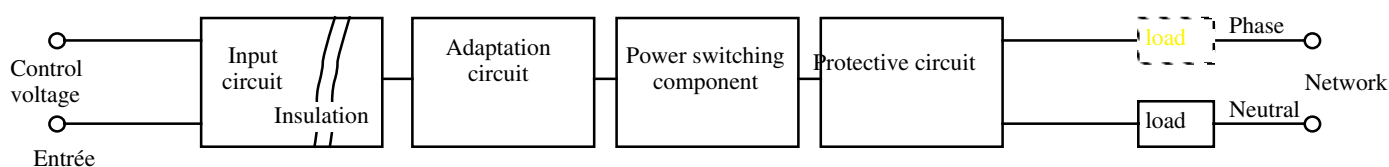

fig. 1 . Constitution of a solid state relay .

1 / INPUT AND INSULATION CIRCUIT :

This circuit provides the galvanic insulation between the input circuit and the rest of the mounting. It is made up of an optical control called an optocoupler (figure 2).

The input current, limited by the resistor R , proportional to the control voltage, is applied to a light-emitting diode (LED) . The light acts on a photosensitive component which transmits information to the output. As the operating current is usually 2 to 3mA , the power required for the control is therefore very low. As the LED takes currents from 2 to 30mA , the control voltage can generally be between 4V and 30VDC. A diode serial or anti-parallel mounted on the LED protects it from a reversed polarity input connection. For an alternating voltage control, a rectifier bridge, a filter and a resistor are fitted (figure 3). So, the control of the LED of the photocoupler is unchanged.

The tolerance on the current similarly allows for deviations from 17 to 80VAC or 90 to 240VAC. A certain amount of **celduc** relays also have a built-in LED displaying the state of the input.

The optocouplers used in the **celduc** relays comply with the VDE0805 standard have an input/output insulation > 3750VRMS , a very low input/output capacity with a very high immunity level : >10 000V/ s .

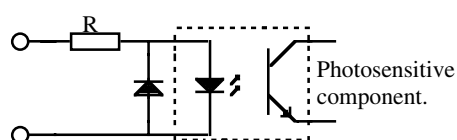

Fig. 2
Input circuit

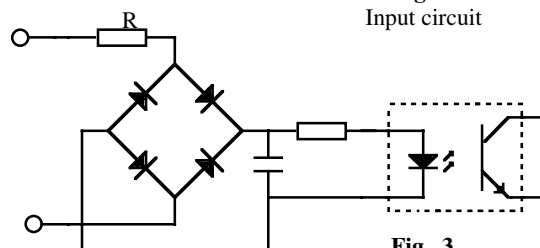

Fig. 3
Input circuit for alternating control



ISO 9001
N° 1993/1106a

celduc[®]
r e l a i s

www.celduc.com

Rue Ampère B.P. 4

42290 SORBIERS - FRANCE

E-Mail : celduc-relais@celduc.com

Fax +33 (0) 4 77 53 85 51

Service Commercial France Tél. : +33 (0) 4 77 53 90 20

Sales Dept.For Europe Tel. : +33 (0) 4 77 53 90 21

Sales Dept. Asia : Tél. +33 (0) 4 77 53 90 19

2 / ADAPTATION CIRCUIT :

This circuit receives the control signal and transmits it to the switching component. According to the type of relay, the making moment can take place at different levels of mains voltage. There are therefore different categories of relays.

2 - 1 -/Zero cross relays:

The power switching only takes place at the start of the half-cycle following the application of the control. Indeed, the switching of the power component is only permitted in the area around the zero crossing . This area is still called the "zero crossing window" or sometimes the "zero crossing level". **celduc** solid state relays have a very low zero crossing level (usually <10 Volts). This control prevents sharp variations in current on all the RESISTIVE loads (Fig. 4) : lamps, heating elements,..... and prolongs the lifetime of these components. This control is also suited to control capacitive loads with a few extra precautions (special application note available on request) **celduc** solid state relays can also be used on inductive loads, even though the zero cross control is not optimised.

2 - 2 /Instantaneous control or random relays:

The power switching takes place from the application of the control voltage (100 s) . This control is most suited to all the CONDUCTIVE type controls due to the dephasing between the current and voltage. (Fig. 5)

2 - 3 /Voltage peak control or peak starting relays :(SCP)

The power switching only takes place at the voltage peak of the half-cycle following the application of the control. This control is particularly suited to the control of TRANSFORMER type inductive saturating loads. This prevents the transformer from being saturated and also significant magnetising current peaks (Fig. 6). Special application note on request.

2 - 4 /Upgraded solid state relays :

Models incorporating more sophisticated or specific interfacing functions :

- * soft start motor control,
- * light or speed control (phase angle controllers : fig 7)
- * heating power control (standard "syncopated" full wave pulse controllers) : fig 8
- * suitable for the switching of loads supplied with DIRECT CURRENT
- * suitable for INTERFACING electronic circuits with power circuits, both INPUT and OUTPUT.
- * using the **celduc** " SOFTLIFE" technology combining the assets of solid state relays : reliability, lifetime, noiseless with those of electromechanical relays : compact, no heating.

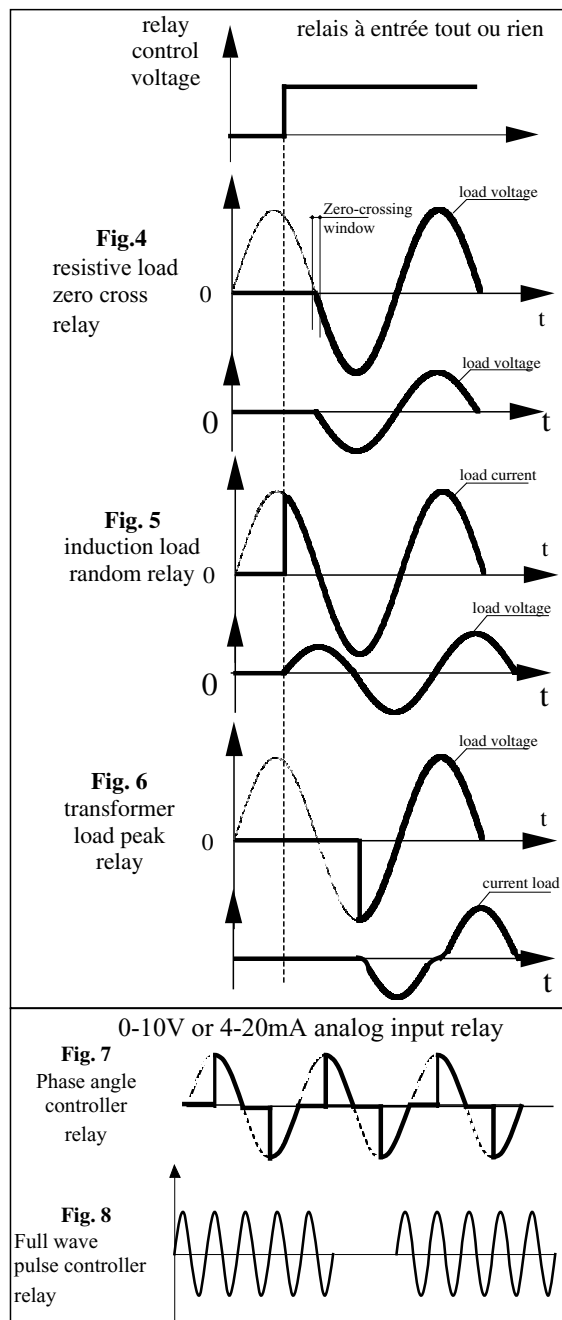

3 — POWER SWITCHING COMPONENT.

3-1 TYPES AND CHARACTERISTICS

The switching components of solid state relays for alternating networks are thyristors or triacs. Thyristors are control gate diodes. They are conductors in one direction only. Two thyristors should be mounted back to back to transmit the 2 half-cycles of the mains (figure 9). Triacs are semiconductors controlled by the gate capable of conduction in both directions. One single triac can switch the 2 half-cycles of an alternating network (figure 10).

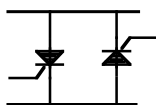

Fig. 9 Back-to-back thyristors



Fig. 10 Triac



ISO 9001
N° 1993/1106a

celduc[®]
r e l a i s

www.celduc.com

Rue Ampère B.P. 4 42290 SORBIERS - FRANCE E-Mail : celduc-relais@celduc.com
 Fax +33 (0) 4 77 53 85 51 Service Commercial France Tél. : +33 (0) 4 77 53 90 20
 Sales Dept.For Europe Tel. : +33 (0) 4 77 53 90 21 Sales Dept. Asia : Tél. +33 (0) 4 77 53 90 19

These various components have a function in common :

-They only conduct provided the suitable current is applied to the control electrode (gate). Once the conduction is made, it is maintained, even if there is no gate current, up to ZERO, or up to at least a current value less than its HOLDING CURRENT (usually 50mA). In a solid state relay this holding current is sometimes indicated. It is only useful if the relay is pulse controlled and is not to be mixed up with the MINIMUM WORKING CURRENT of a solid state relay. Indeed, when the control is applied permanently, if the current is less than the holding current, it is the pilot control circuit of the power component which provides the conduction of the current of the load.

There are 2 other ways to make these power components conduct but do however hinder the use and are to be warned against :

- Arcing by dv/dt (static) : With the component in the blocked state (not controlled), if a sudden variation of voltage is applied across its terminals, the Anode / Gate parasitic capacity generates a gate current ($i = Cdv/dt$) likely to lead to the conduction of the semiconductor during a mains half-cycle.

-Arcing by PEAK VOLTAGE. If a significant voltage higher than the maximum allowable voltage (MAX PEAK VOLTAGE) is applied, there is an avalanche effect on the semiconductor and it becomes conductive. This arcing can be destructive if it is followed by a significant current.

Standard triacs also have another disadvantage : when a triac is conductive, at the time where the current is cancelled, a voltage must not be reapplied too quickly across its terminals as this may stop it from blocking.

When switching OFF on an inductive load (whatever the type of relay), the mains voltage is reapplied quickly when the current is stopped due to the dephasing between the current and voltage. The resistance of a triac on this reapplication of voltage called dv/dt on the switching ($(dv/dt)_c$) greatly depends on the slope of the current at the time of blocking ($(di/dt)_c$). (fig. 11). This is why triacs are only used for small currents.

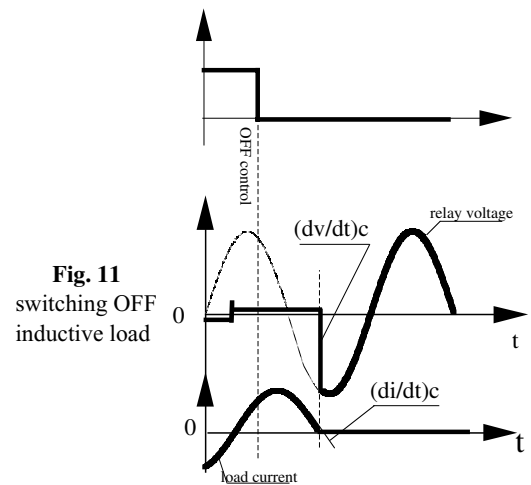

Fig. 11
switching OFF
inductive load

In order to overcome these disadvantages, **celduc** uses more efficient components as opposed to standard triacs :

-LOW POWER: Use of new generation triacs with high switching characteristics : SNUBBERLESS TRIACS or HIGH LEVEL SWITCHING.

-MEDIUM POWER : Use of ALTERNISTORS which are practically 2 thyristors diffused over the same silicon chip.

-HIGH POWER: Use of BACK-TO-BACK THYRISTORS.

celduc relays have a high switching performance.

On the other hand, the majority of the power components used by **celduc** have a static $dv/dt > 500v/s$ (compared to the 200v/s standard). For peak voltage resistance **celduc** has generalised **600V** for the 110 and 230VAC relays and **1200V** for the 400VAC relays and offers **1600V** relays. For additional protection see the protection/. For the immunity of products see the EMC/.

3-2 THERMAL

3-2-1 VOLTAGE DROP AT ON STATE

At on state, solid state relays have residual voltage. This drop in voltage at the on state is in phase with the current and takes the form shown in figure 12 :

V_a : ARCING VOLTAGE or minimum voltage required to send a correct control to the power component (appears on each zero crossing of the current). This voltage has been reduced by a maximum on the **celduc** solid state relays (usually 7 to 8V instead of 20V : which reduces the deformations of the mains sine wave and the level of conducted emission (EMC) . This voltage (not to be confused with the zero cross voltage which only takes places on the half-cycle after the application of the control (3-2)) calls for a minimum working voltage of the solid state relays : usually 12 VAC .

V_t : Threshold voltage due to the junction of the semiconductor : usually 0.8 to 1 V .

(This voltage drops with the temperature : approx. 2mV/°C).

r_t : resistance at the on state of the semiconductor and connections :

usually 5 to 30μΩ according to the rating of the relay.

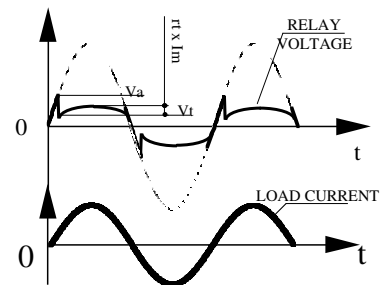

Fig.12

voltage drop at on state
(A precise measurement can only be made
with an oscilloscope).

3-2-2 COOLING AND CHOICE OF HEATSINK :

The switching component must be suitably cooled so that the junction temperature does not exceed the values specified : usually 110 or 125°C .

a) **REMINDER OF OHM'S LAW : $\Delta T = R_{th} \times PD$ where**

ΔT = Difference of temperature between the junction and the ambient air

R_{th} = Junction/ambient air thermal resistance. It can be made up of several serial mounted thermal resistors (R_{th}).

PD = Power dissipated by the relay. Expressed in Watts (joules per second), corresponds to the thermal current or the calories to be discharged from the relay, mainly depends on the current crossing the relay.



ISO 9001
N° 1993/1106a

celduc[®]
r e l a i s

www.celduc.com

Rue Ampère B.P. 4

42290 SORBIERS - FRANCE

E-Mail : celduc-relais@celduc.com

Fax +33 (0) 4 77 53 85 51

Service Commercial France Tél. : +33 (0) 4 77 53 90 20

Sales Dept.For Europe Tel. : +33 (0) 4 77 53 90 21

Sales Dept. Asia : Tél. +33 (0) 4 77 53 90 19

b) MODULES (without external heatsink) : It is the case, the resin, the internal heatsink which act as a dissipator to discharge the calories .

In an SK type case, the junction/ambient air thermal resistance is in the region of 20 to 25 j/W

=> max PD = (Max. junction temperature — Ambient temperature)/20 max PD = (110 - 30) /20 = 4 Watts hence max rms I at 30jC = 4 Amperes. (see 5 A). For the modules, a curve specifies the maximum current according to the ambient temperature.

c) RELAYS WITH BASE PLATE (MACROMODULES) MOUNTED ON HEATSINK :

The heatsink can be determined either by calculation or directly from the curves provided by **celduc**.

c-1) Determination by calculation :

To simplify things and presuming that the relay is mounted correctly i.e. mounting with thermal conductive grease (silicon grease or thermal interface proposed by **celduc**), that the relay/heatsink contact as well as the tightening of the fastening screws are correct, the thermal mounting resistance can be ignored (usually 0.1j/w).

In general, the known elements are the power to be dissipated (PD) : **Pd = 0.9xVtIxI + rtxIxI** (determined according to the RMS current crossing the relay) and the ambient temperature (Tamb). The max junction temperature (Tjmax) and junction / case thermal resistance values (Rth j/b or Rthj/c) are given in the **celduc** specifications.

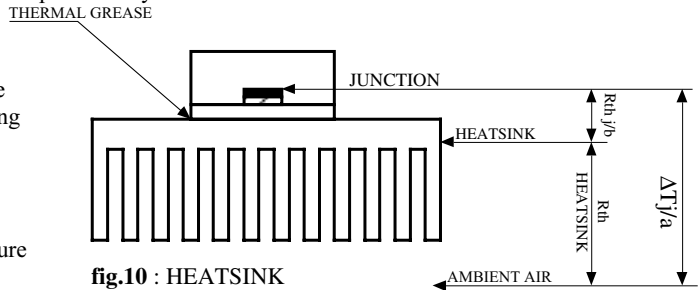

fig.10 : HEATSINK

① $R_{th} < T / PD$

On the other hand, the temperature of the relay, therefore, the heatsink must be limited to max Tcase (90 or 100jC) specified in the specifications

② $R_{th \text{ heatsink}} < (max \text{ Tcase} - ambientT) / PD$

Example : RMS I = 20A -----> PD = 24Watts (for a relay with Vt = 1V and rt = 15 μΩ) Max ambient T = 30jC

- ① Si Rth j/c = 1,1°/W, Tj max = 125°C , T case max = 90°C
- ② $\sum R_{th} < (125-30)/24 = 3,9°/w$ -----> Rth radiateur < 3,9-1,1 = 2,8°/W
- Rth radiateur < (90-30)/24 = 2,5°/W

Le choix se portera sur un radiateur de Rth < 2,5°/W -----> standard **celduc** 2°/W

c-2) using the curves given by celduc (fig 13):

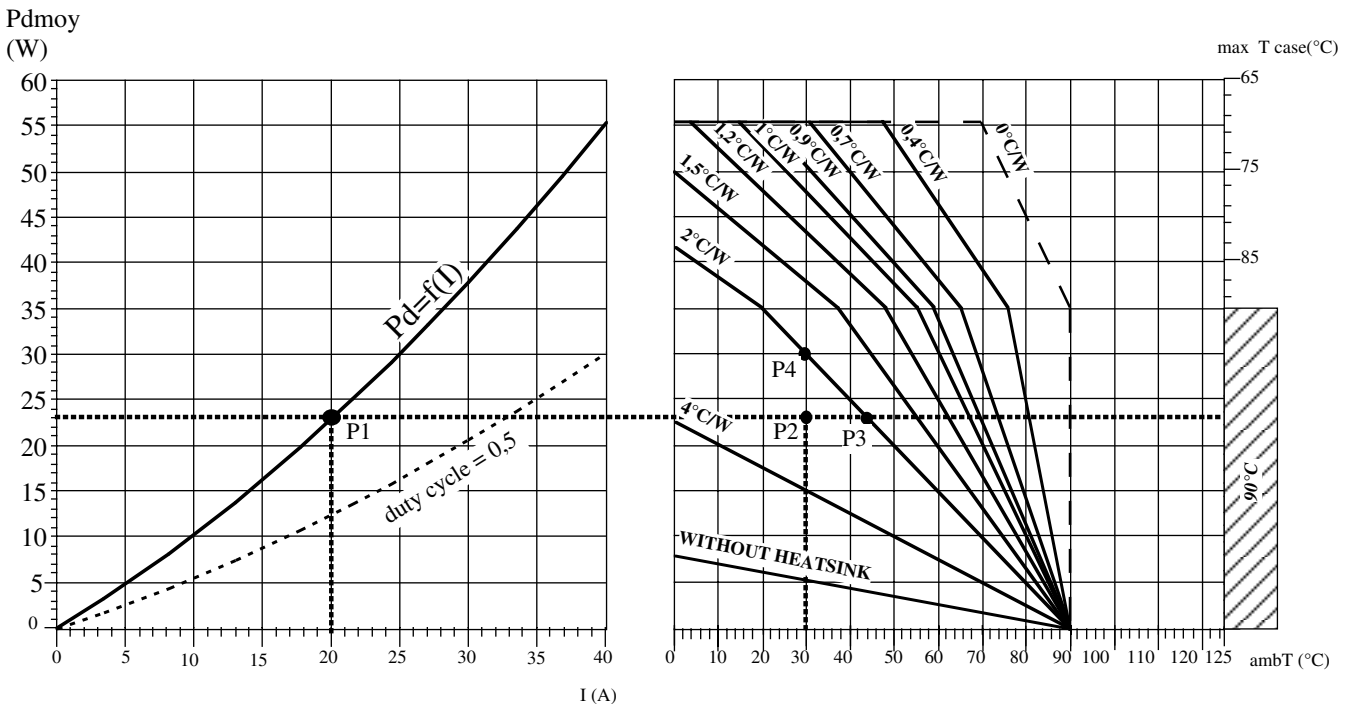

fig 13: THERMAL CURVES



celduc[®]
relais

www.celduc.com

Rue Ampère B.P. 4 42290 SORBIERS - FRANCE E-Mail : celduc-relais@celduc.com
 Fax +33 (0) 4 77 53 85 51 Service Commercial France Tél. : +33 (0) 4 77 53 90 20
 Sales Dept.For Europe Tel. : +33 (0) 4 77 53 90 21 Sales Dept. Asia : Tél. +33 (0) 4 77 53 90 19

The type of heatsink to be used can be determined directly according to the switched current and the ambient temperature. previous example with RMS I = 20Amperes and max. ambient temperature = 30°C

Operating mode /fig 13:

- identify the current to be switched on the abscissa of the left hand curve.
- plot a vertical line from this point up to the curve $Pd=f(I)$ (the power to be dissipated can be read on the ordinate).
- from the point obtained (P1), a horizontal line is plotted to the right hand curve.
- identify the ambient temperature on the abscissa of the right hand curve.
- plot a vertical line from this point until you meet the horizontal line previously plotted. This point (P2) determines the type of heatsink to be used.
- choose the heatsink corresponding to the curve located above this point. In the example $2_i/W$

You can see that with a heatsink of $2_i/W$ and 20Amperes, the ambient temperature should not exceed 43°C (P3). with a heatsink of $2_i/W$ and an ambient temperature of 30°C the maximum current could reach 25 Amperes (P4).

It is to be pointed out that this determination is performed when permanent operation is involved. For intermittent uses : duty cycle < 1 , you can take the mean power dissipated or use the "Power dissipated" curve with the suitable duty cycle (in the above example : duty cycle = 0.5). This is only true if the duty cycle remains greatly inferior to the thermal constant of the heatsink. You must watch out for the preheating time of machines which may correspond to permanent operation.

The ordinate of the right hand curve gives the maximum case temperature of the relay (max Tcase) according to the power dissipated.

Example : for mean $Pd = 40watts \rightarrow T_{case}$ must not exceed 85°C

d) Mounting without heatsink or mounting on backplate of cabinet

A curve without heatsink is given for the SC or SG type solid state relays.

When mounted on the backplate of a cabinet, the relay/plate contact must be correct.

An aluminium backplate of the correct thickness of 150mm x 150mm corresponds to approximately $4_i/W$

An aluminium backplate of the correct thickness of 300mm x 300mm corresponds to approximately $2_i/W$

In all cases, you are advised to perform a test and measure the heating. A steel plate will have greater thermal resistance,.....

e) Mounting several relays on one heatsink (fig 14) Thermal constant notion.

A lot of solid state relays are mounted on the backplates of cabinets on one heatsink.

This solution has the advantage of optimising the heatsink which has a good thermal capacity at the time of heating of the machine (preheating) when all the solid state relays are called upon permanently. The value of the thermal constant of the **celduc** heatsinks is specified. This C_{th} value (figure 15) corresponds to the time of the rise in temperature of the heatsink : $C_{th} = 67\%$ the time that the heatsink takes to stabilise (T_s value given in still air)

In control mode this mounting gives rise to an optimum distribution of the calories over the whole heatsink.

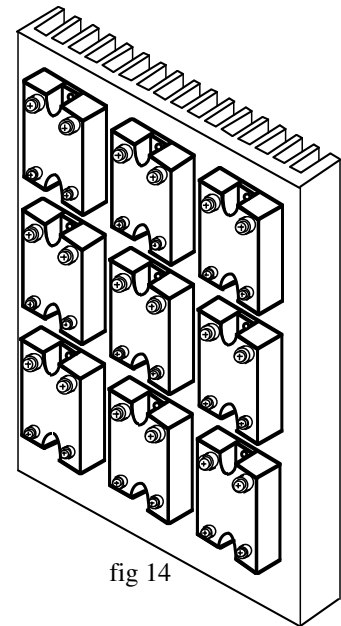

fig 14

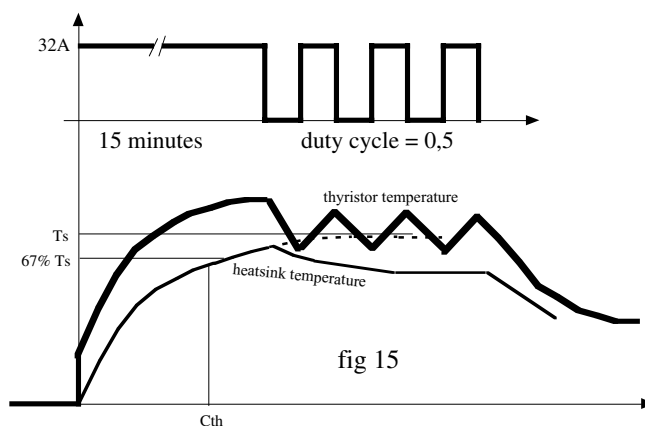

fig 15

To determine the heatsink, add all the powers dissipated for each relay. Redo the thermal resistance calculation required : $R_{th} = T / Pd$. The best solution is to carry out a thermal test in the worst operating conditions and to check that the temperature of the heatsink does not exceed the maximum specified.



ISO 9001
N° 1993/1106a

celduc[®]
r e l a i s

www.celduc.com

Rue Ampère B.P. 4

42290 SORBIERS - FRANCE

E-Mail : celduc-relais@celduc.com

Fax +33 (0) 4 77 53 85 31

Service Commercial France Tél. : +33 (0) 4 77 53 90 20

Sales Dept.For Europe Tel. : +33 (0) 4 77 53 90 21

Sales Dept. Asia : Tél. +33 (0) 4 77 53 90 19

f - : Using ready-to-use relays (fig 16)

celduc proposes a range of ready-to-use relays which can be directly DIN rail mounted or screwed on.

The values of the switching current are directly given in compliance with the European standards, i.e. corresponding to limited temperature rises.

- max 50°C for heatsink
- max 50°C for cover

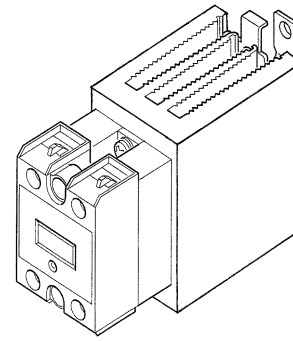

fig 16

g) Precautions and tips:

- The values of the power dissipated according to the current crossing the relay are given for permanent operation on the **celduc** curves. In the case of intermittent operation, some curves give the power rating with a duty cycle = ton/toff < 1. These values are only valid for short periods, less than the thermal time constants of the heatsinks.

- The thermal resistance of a heatsink is defined in determined conditions of use : **vertical mounting (fig 17)**, In the case of use in a severer atmosphere (cabinet with no aeration), include a safety coefficient (20 to 30%).

- The Thermal resistance values of the **celduc** heatsinks are given in natural convection, in the vertical position and in an enclosed housing. Forced ventilation around the SSR and its heatsink (fan) can allow for the size to be reduced significantly :

The thermal resistance of a heatsink is divided by 2 with an air speed of 1.5 m/s and by 4 with an air speed of 5m/s.

The use of an oversized heatsink boosts the reliability and lifetime of solid state relays.

vertical mounting

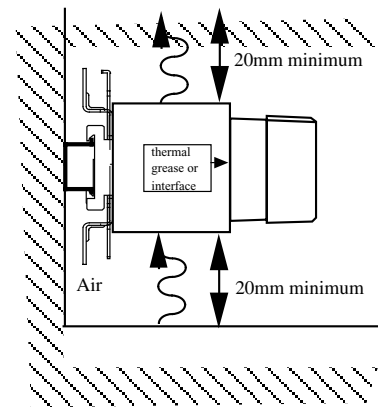

fig 17

4 - PROTECTION CIRCUIT :**4-1) PROTECTION BY RC NETWORK OR SNUBBER**

Limits sudden variations of voltage : dv/dt and $(dv/dt)_c$ (fig 18)

These can arise :

- on switching on.
- on switching inductive loads.
- on mains interference.

The **celduc** relays have been improved in terms of resistance to these factors enabling the RC network to be reduced substantially or practically eliminated.

--> **celduc** guarantees its relays for immunity in keeping with the standard EN61000-4-4 which corresponds to quick transients (see EMC/). The majority of relays are guaranteed with resistances without arcs at 2kVolts (even 4 kVolts) whereas the test is performed with rising times to within a nano second.

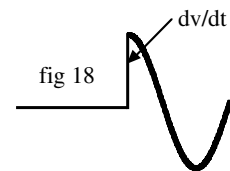

fig 18

4-2) VOLTAGE PROTECTION BY VOLTAGE SURGE SUPPRESSOR

Limits interference by voltage surges.

Distribution networks are after "polluted" by high amplitude interference (fig 19).

voltage pulses. These voltage peaks are dangerous for the semiconductors used in solid state relays (see /3-1: arcing by peak voltage).

celduc recommends the use of **VARISTORS** placed at the power terminals of solid state relays.

A varistor (or varistance or VDR) is a non-linear component the resistance of which varies with the voltage.

At nominal voltage, the varistor is practically not conductive. At high voltage of interference, it represents a low impedance which limits the voltage surges to acceptable values for the relay.

celduc mounts a varistor on some ranges of relays as standard and as an option on others (minimum quantities) and **strongly advises** them for other products.

The new European mains voltages : **230V – 10% in single phase** and **400V –10% in three phase** call for 275V varistors on the 230V network and 460V on the 400V network. There are different sized varistors which absorb either more or less energy : We recommend the use of at least size "14" .

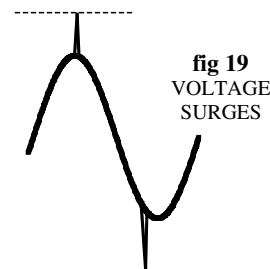
fig 19
VOLTAGE
SURGES

ISO 9001
N° 1993/1106a

celduc[®]
r e l a i s

www.celduc.com

Rue Ampère B.P. 4

42290 SORBIERS - FRANCE

E-Mail : celduc-relais@celduc.com

Fax +33 (0) 4 77 53 85 51

Service Commercial France Tél. : +33 (0) 4 77 53 90 20

Sales Dept.For Europe Tel. : +33 (0) 4 77 53 90 21

Sales Dept. Asia : Tél. +33 (0) 4 77 53 90 19

AS A GENERAL RULE :

- * The **celduc** solid state relays suitable for resistive loads : SC9, SGT9 series have a high immunity level as per EN61000-4-4 => an RC is not necessary. It is strongly advised to use a voltage surge suppressor.
- * The **celduc** solid state relays suitable for all loads : SC8, SGT8 series and the **celduc** random solid state relays : SC7, SGT7 series have a very high immunity level as per EN61000-4-4 and are fitted with an internal RC network. It is strongly advised to use a voltage surge suppressor which is often integral in the SV products.

C - OTHER IMPORTANT CHARACTERISTICS :**1) PEAK VOLTAGE :**

--> In power electronics, the general rule is to have semiconductors with a voltage withstanding double that of the peak voltage of the network. This is why **celduc** recommends 600Vpeak relays on 12-280VAC networks ; 1200Vpeak relays on 24-520VAC networks and 1600V for networks up to 600VAC.

It is to be pointed out that some loads : capacitive, motors, etc., may generate voltage surges. In this case the peak voltage of the relay must account for these surges. celduc proposes relays of 600V, 1200V and 1600volts as standard. See solid state relay selection guide .

2) INSULATION :

--> All the **celduc** relays have an insulation voltage between input and output of 4000VAC .

The output/heatsink insulation is from 2500VAC to 4000AVC depending on the models, in compliance with the European and international standards.

The standard IEC947-1 (or EN60947) specifies the voltage assigned to shock resistance = U_{imp} . The majority of **celduc** products are specified at $U_{imp}=4000V$ and are defined for a degree of pollution 2 as per IEC664-1.

3 LEAKAGE CURRENT

A solid state relay in the blocked state does not have an infinite impedance across its terminals. A low residual current circulates in the load called the leakage current.

This is due to :

-the leakage current of the switching component. This exponentially varies with the junction temperature. It stays very low if the junction temperature remains reasonable.

-the internal circuits acting as an interface and pilot controlling the power. The **celduc** new generation relays have seen this current go from 2.5mA to less than 0.2mA.

-the RC protection networks : The improvement of the characteristics of the **celduc** relays means that this RC can be minimised. This gives rise to a maximum reduction in this current leakage due to the RC and which depends on the mains voltage and the frequency of the network. $I_c = 6.28 \times U \times C \times F$.

This leakage circuit may be harmful in pilot controlling very low loads (small solenoid valves, etc) as this current may suffice to maintain the load supplied.

As opposed to a lot of solid state relays, the **celduc** solid state relays have a reduced leakage current and can operate without problem on **very small loads**.

Given the existing leakage current in a solid state relay, the terminals must be considered as being permanently live.

4) NOMINAL CURRENT

The current which flows in the relay must not exceed the maximum current of the power component during permanent operation. This current is directly proportional to the size of the silicon chip mounted in the solid state relay and depends on the cooling.

celduc usually uses well-sized chips with respect to the maximum current stated. To find out the actual size of the chips used by relay manufacturers, **it is interesting to compare the surge values (I_{tsm} and I_{2t}) which are the values directly proportional to the size of the semiconductors** (see next/).

The **celduc** range is **4A- 12A-25A-50A-75A-95A-125A**. However, this maximum current may only be reached provided the temperature of the power component does not exceed the maximum allowable value (usually 125°C - see/ : thermal).

IN THE CHOICE OF CURRENTS/TYPE OF LOADS, REFER TO THE APPLICATIONS PART where the categories of use are defined : AC-51 ; AC-53;.....

THERMAL FATIGUE phenomenon : Electronic power components which withstand many hot/cold thermal cycles, (which can be the case for solid state relays with on/off operation) undergo a THERMAL FATIGUE phenomenon likely to affect the lifetime of the component (see LIFETIME/).

**=> AS A GENERAL RULE, SOLID STATE RELAYS SHOULD ALWAYS BE OVERSIZED.
IT IS ADVISED TO DULY COOL SOLID STATE RELAYS.**



ISO 9001
N° 1993/1106a

celduc[®]
r e l a i s

www.celduc.com

Rue Ampère B.P. 4

Fax +33 (0) 4 77 53 85 51

Sales Dept.For Europe Tel. : +33 (0) 4 77 53 90 21

42290 SORBIERS - FRANCE

Service Commercial France Tél. : +33 (0) 4 77 53 90 20

Sales Dept. Asia : Tél. +33 (0) 4 77 53 90 19

E-Mail : celduc-relais@celduc.com

5) SURGE CURRENT : ITsm (maximum surge)

The semiconductor components used can accept brief surges. This peak current ITsm : ACCIDENTAL NON REPETITIVE SURGE CURRENT AT ON-STATE is given for a mains half-cycle for triac type output relays, i.e. for a duration of 10ms in 50hertz and a mains cycle for thyristor type output relays, i.e. for a duration of 20ms in 50hertz . This peak current is in general 10 times the nominal current.

celduc gives the characteristics of the value $I_{tsm} = f(t)$ with 2 different curves (fig 21):

1 : Itsm value without voltage reapplied : this curve corresponds to the values not to be exceeded when a short-circuit occurs without the risk of destroying the semiconductor. The temperature of the silicon rises above 200°C and the relay loses its switching capacity. It is the protection circuit (fuse, circuit-breaker) which ensures the switching. This constraint is not repetitive, i.e. limited in the number of times in the life of the product (<100 times)

2: surge value with voltage reapplied : this curve corresponds to the value not to be exceeded to ensure the relay keeps its switching capacity. These curves are generally given for an initial junction temperature of 70°C. The current surge then gives rise to an instantaneous rise in temperature of the chip limited to the acceptable value for the semiconductor (generally 125 or 150°C).

This constraint can be repetitive. For inrush currents on starting :

- INCANDESCENT LAMPS (8 to 10 IN)
- CAPACITIVE LOADS
- MOTORS (4 to 8 IN)
- THERMAL HEATING ELEMENTS (1.4 In).
- TRANSFORMERS (up to 100In)

The repetitive curve Itsm checking the influence on the life time (see LIFETIME/) must be used.

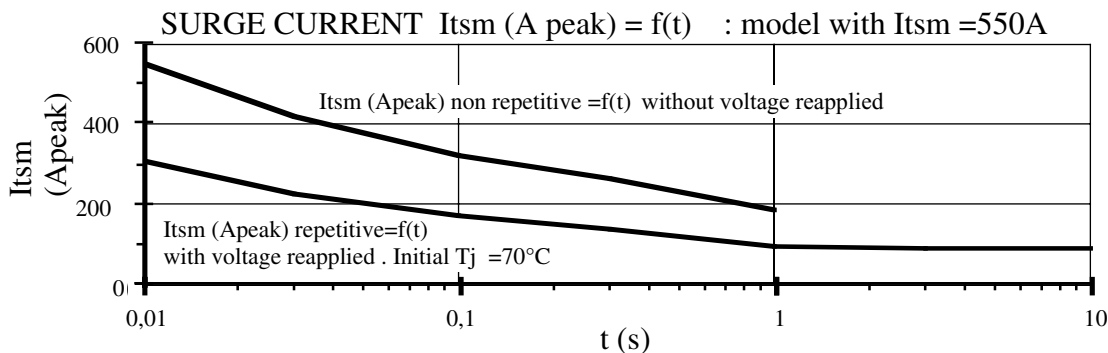

fig 21

6) I2t or MELTING INTEGRAL :

Used for very brief surges (<10ms) . This value corresponds to the constraint current value not to be exceeded for a brief time so as not to destroy the power semiconductor (melting). This short time surge occurs during a short-circuit of the load. This value corresponds to the non repetitive Itsm for 10ms .

Example : relay with I2t of 5000 A2s ----> Imax = 1000A for 10ms

7) PROTECTING SOLID STATE RELAYS FROM SHORT-CIRCUITS OF THE LOAD :

During a short-circuit, the line must be protected according to the standards in force (NFC15100 & CEI 364) and therefore have a device capable of stopping the current within a reduced period of time thereby protecting persons and equipment.

This cut-off device must be all the more rapid if it is associated to a conventional thyristor or triac type solid state relay as these components can only withstand a limited peak current.

During a short-circuit on the line, the waveform obtained (fig 22) depends on the presumed short-circuit current of the line (Icc inrush current and reached if there is no protection device).

The rapidity of the protection device is characterised by the quantity

$i^2 dt$ which is the sum of of the pre-arc I^2t and and the arc I^2t .

$\int_{t_0}^{t_t} i^2 dt$ qui est la somme de $\int_{t_0}^{t_t} I^2t$ de préarc et de $\int_{t_0}^{t_t} I^2t$ d'arc.

This I2t value called thermal constraint, is used to verify that the components of the circuit are duly protected. This I2t characteristics is only valid if the duration of the surge is of a short duration (<10ms) . Beyond this the RMS value of the current must be considered.

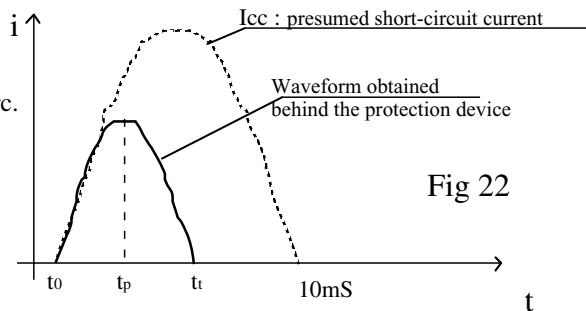

Fig 22



www.celduc.com

Rue Ampère B.P. 4 42290 SORBIERS - FRANCE E-Mail : celduc-relais@celduc.com
 Fax +33 (0) 4 77 53 85 51 Service Commercial France Tél. : +33 (0) 4 77 53 90 20
 Sales Dept.For Europe Tel. : +33 (0) 4 77 53 90 21 Sales Dept. Asia : Tél. +33 (0) 4 77 53 90 19

The I2t values of the **celduc** relays are the most efficient on the market with :

celduc RANGE							
RELAY RATING	12A	25A	40A	45/50A	75A	95A	125A
I2t (A2s) (<10ms)	72	312	610	1500	5000	11000	20000

6-6) PROTECTION BY FUSES :

celduc recommends fuses adapted to the solid state relays for each type of load,:

- resistive load : use of FERRAZ GRB or GRC fuses
 - on motor : use of standard "am" fuses with adaptation of the rating of the relay.
- As a general rule, a correct safety margin of fuse I2t value would be <1/2 I2t relay.

An important factor must be taken into account : the thermal fatigue of the fuse. This is why all the associations proposed by **celduc** have been tested in the FERRAZ laboratory.

6-7) PROTECTION BY CIRCUIT-BREAKERS :

celduc is currently working on self-protected solid state relays, however with the current technology self protection is put to the detriment of the drop in voltage at on-state, therefore a bigger heatsink and added costs which remain high.

--> THE SOLUTION : **SOLID STATE RELAY ASSOCIATED TO A HIGH-SPEED CIRCUIT-BREAKER :**

Mechanical circuit-breakers have made a great deal of progress. Very compact modular type circuit-breakers can now be found with thermal and magnetic tripping meaning they are capable of breaking on a surge but also on a short-circuit. Their breaking capacity is more and more efficient and reaches 15 to 25 kA in Icu current (ultimate current for which it is preferable to change them) and 10 to 20 kA in Ics current (Operating switching current).

The magnetic tripping depends on the type of circuit-breaker.

The new high speed circuit-breakers of the "Z curve" type trip at a current corresponding to 2 to 3 In . These circuit-breakers (ABB, MERLIN GERIN, KLOCKNER & MOELLER, ...) are in fact "short-circuit current limiters" . They are designed to limit the breaking time and the value of the short-circuit current in order to simultaneously reduce the two factors of the on-state thermal stress (I2t on-state) .

The short-circuit current limitation value and the breaking time are of prime importance in protecting downstream circuits against the damage incurred by short-circuits of the loa

6-8) CHOICE OF CIRCUIT-BREAKER ASSOCIATED TO SOLID STATE RELAY :

In order to determine the circuit-breaker, you must know the presumed short-circuit current (called Icc or Ip), calculated at the point where it is installed. Fitters usually know this presumed short-circuit current at a given point of the installation, however, you can ask **celduc** for the specific application note. The circuit-breaker must have a breaking capacity at least equal to Icc at the point where it is installed in compliance with the NF C standard 15-100/434-2-1 (CEI364) .

It is the residual short-circuit current which must be taken into account to determine the degree of coordination and selectivity.

The value of the residual short-circuit current and its breaking time depend on this residual short-circuit current Icc and the type of circuit-breaker.



ISO 9001
N° 1993/1106a

celduc[®]
r e l a i s

www.celduc.com

Rue Ampère B.P. 4

42290 SORBIERS - FRANCE

E-Mail : celduc-relais@celduc.com

Fax +33 (0) 4 77 53 85 51

Service Commercial France Tél. : +33 (0) 4 77 53 90 20

Sales Dept.For Europe Tel. : +33 (0) 4 77 53 90 21

Sales Dept. Asia : Tél. +33 (0) 4 77 53 90 19

Solid state relays are generally fitted after a series of protection and isolating devices and the cross sections of the wires are already reduced which limits the short-circuit current to values under 5000 Amperes. Given these conditions, the I2t values obtained using "Z curve" high-speed circuit-breakers in the event of short-circuits of the load can be accepted by the **celduc** high I2t solid state relays. To verify the level of protection, just refer to the manufacturers' curves which give :

o The tripping curves ----> to check the surge protection (thermal)

example : A 16A circuit-breaker will trip with a surge of 30A in a maximum of 20 seconds.

oThe dynamic stress curve ----> to see the limiter effect of these circuit-breakers.

example : RMS Icc = 4000A ----> max ID on-state =2400 Amperes for a 16 A circuit-breaker.

oThe thermal stress curve I2t ----> to determine the max I2t accepted by the circuit-breaker and that goes through the solid state relay on a short-circuit according to the Icc of the line at the point of installation .

example : Icc = 2000A circuit-breaker rating = 16 A I2t max = 3200A2s

Icc = 4000A circuit-breaker rating = 25 A I2t max = 10000A2s

These values are the maximum given by the manufacturer. It is, nonetheless, to be pointed out that when using zero cross solid state relays associated with circuit-breakers, controlling the zero cross relay limits the thermal stress.

celduc has developed high I2t relays in the same standard cases for the use of these circuit-breakers :

Relay 45/50A : I2t >1500A2s (typ >2000A2s)

Relay 75A : I2t >5000A2s (typ >7000A2s)

Relay 95A : I2t >11000A2s (typ >12500A2s)

Relay 125A : I2t >20000A2s(typ >21000A2s)

A certified certificate from the ABB laboratory has been drawn up in association with the **celduc** solid state relays giving the presumed short-circuit current limit values for the relay ratings corresponding to high speed circuit-breakers of the brand.

Ratings tested by the ABB laboratory :

RELAY RATING	Limits of presumed short-circuit current (Icc) or prospective current (Ip)	
	circuit-breaker Z16	circuit-breaker Z50
50A - 5000A2s	3000A	2000A
95A - 11000A2s	5000A	3000A
125A -20000A2s	7000A	4000A

Note : other associations are possible as, in general, the presumed short-circuit currents are lower.

celduc has many applications where the association of 50A relays with 5000A2s with a Z16 circuit-breaker operates perfectly.

D : SPECIAL RELAYS :

1 — RELAYS FOR DIRECT CURRENT

These are relays designed for switching direct currents. They have a structure identical to alternating relays. The switching components is a BIPOLAR or MOS (or IGBT) transistor according to the models working in saturated or blocked state.

The protection on these relays is generally a parallel mounted "free wheel" diode on the load if it is inductive.

The heatsinks are determined in the same way as for alternating current.

The **celduc** range of DC relays is currently limited to 100V 60 A or 200V 20A(see specifications of DC relays).

Alternatively, **celduc** engineers special relays to specifications adapted to each use : Automotive relays, DC motor controls (speed and rotation) — MAKE ENQUIRIES WITH**celduc** .



ISO 9001
N° 1993/1106a

celduc[®]
r e l a i s

www.celduc.com

Rue Ampère B.P. 4

42290 SORBIERS - FRANCE

E-Mail : celduc-relais@celduc.com

Fax +33 (0) 4 77 53 85 51

Service Commercial France Tél. : +33 (0) 4 77 53 90 20

Sales Dept.For Europe Tel. : +33 (0) 4 77 53 90 21

Sales Dept. Asia : Tél. +33 (0) 4 77 53 90 19

2 — INTERFACE MODULE RELAYS

These relate to input and output modules are designed for control interfaces. There are mainly 4 On/Off types available :

AC OUTPUT MODULES

DC OUTPUT MODULES

AC INPUT MODULES

DC INPUT MODULES

The new generations are fully compatible with commercial electromechanical relays. They have the advantage of replacing them along with all the assets of solid state relays.

For instance, the new SP/ST range compatible with siemens/schrack/finder relays : RP/RT type

(see specific documentation)

3 — UPGRADED RELAYS

celduc engineers more sophisticated relays as standard equipment. For instance : PROPORTIONAL CONTROLLED RELAYS (FULL WAVE PULSE CONTROLLERS), MOTOR STARTING RELAYS (SOFT START), ROTATION REVERSING RELAYS, FLASHING, "SOFT-LIFE" technology relays (built-in by—pass),.....

(see specific documentation)

4 — SPECIAL AND POWER ELECTRONIC RELAYS

Thanks to its structure and long-standing experience in the field (>20 years) **celduc** has the special asset of being able to meet with its customers' requirements hence the development of special relays. A few examples being :

CURRENT CONTROL RELAY: the relay is controlled by the current (eg 6ARMS) instead of a voltage control.

AC/DC RELAYS

SELF-PROTECTED RELAYS (short-circuit , temperature and DIAGNOSTIC)

BATTERY CHARGER CHOPPERS,

POWER CHOPPERS UP TO 600kW , etc.....

Do not hesitate to make enquiries with us for all your electronic functions.

E — RELIABILITY AND CONFORMITY

1 -TECHNOLOGY :

celduc uses the most modern of technology for these solid state relays : CMS , POWER HYBRIDS with traditional technology and now DCB (Direct Copper Bonding: FIG 23) , which reduces the thermal impedances, with reduced mechanical stresses due to a low difference in temperature between the junction and the heatsink giving rise to an increase in the lifetime.

The optimisation of cases, the technology and the thermal dissipation allow for a maximum POWER/DIMENSION RATIO on the **celduc** products.

The future of power cases (MACROMODULES) is promising thanks to the ability to integrate THE ELECTRONIC FUNCTION ON DEMAND with the advantage of a strong, moulded case.

The use of this technology along with ASIC technology or microcontrollers make electronic selector switches progress to so-called "INTELLIGENT" functions at least capable of self-protection, giving a DIAGNOSTIC and dialoging with the peripheral equipment.

2- TESTS

All the **celduc** solid state relays undergo 2 tests : 1 before potting and one on the finished product with a check of all the characteristics. On the other hand, reliability tests (by spot checking) are performed on all the sensitive components used in the relays and temperature tests (BURN-IN TEST) are conducted on the majority of the **celduc** relays.

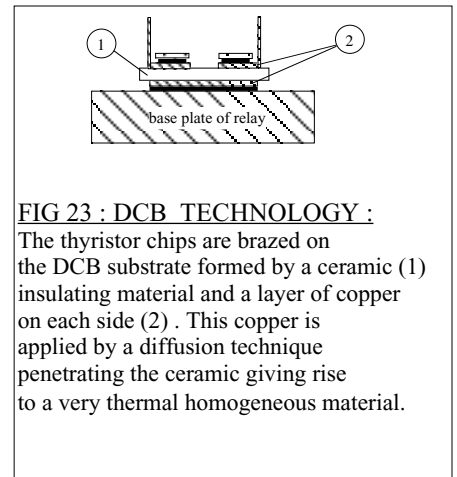

FIG 23 : DCB TECHNOLOGY :

The thyristor chips are brazed on the DCB substrate formed by a ceramic (1) insulating material and a layer of copper on each side (2) . This copper is applied by a diffusion technique penetrating the ceramic giving rise to a very thermal homogeneous material.



ISO 9001
N° 1993/1106a

celduc[®]
r e l a i s

www.celduc.com

Rue Ampère B.P. 4

Fax +33 (0) 4 77 53 85 51

Sales Dept.For Europe Tel. : +33 (0) 4 77 53 90 21

42290 SORBIERS - FRANCE

Service Commercial France Tél. : +33 (0) 4 77 53 90 20

E-Mail : celduc-relais@celduc.com

Sales Dept. Asia : Tél. +33 (0) 4 77 53 90 19

3 —LIFETIME

The lifetime of a relay is very high. If the relay is used in correct operating conditions : adherence to the voltage, current, characteristics. The lifetime is mainly related to the thermal fatigue (---> GOOD SIZING of the relay and heatsink) and ageing of the optocoupler .

celduc only uses high quality optocouplers :

MTBF of a SIEMENS optocoupler : MTBF > 2 x 10E6 hours i.e. 228 years .

With regard to the thermal fatigue, **celduc** has extensive experience in the power field and provides a curve of the number of switching operations according to the variation in temperature. The technology used is of importance so that the temperature of the junction is as close to the temperature of the heatsink. Depending on the types of load, 2 types of operations are mainly to be found :

1 : on resistance load in temperature control : (fig 24)

In this type of application, 2 operating modes are to be noted :

* on starting with a preheating period (DT1)

* in control (DT2)

DT2 is usually low and DT1 rare

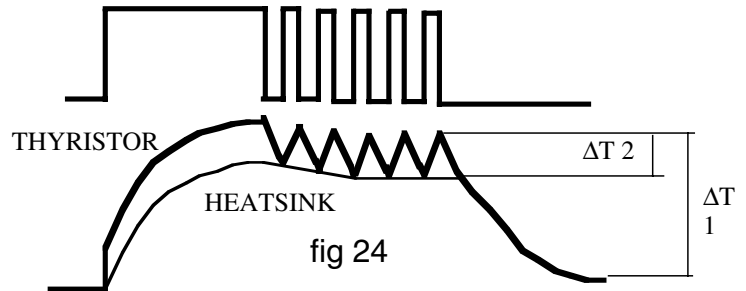

2 : on charge with current peaks on starting : motors, lamps : (fig 25)

In this type of application : DT1 is low and DT1 is more important and depends on the number of starts

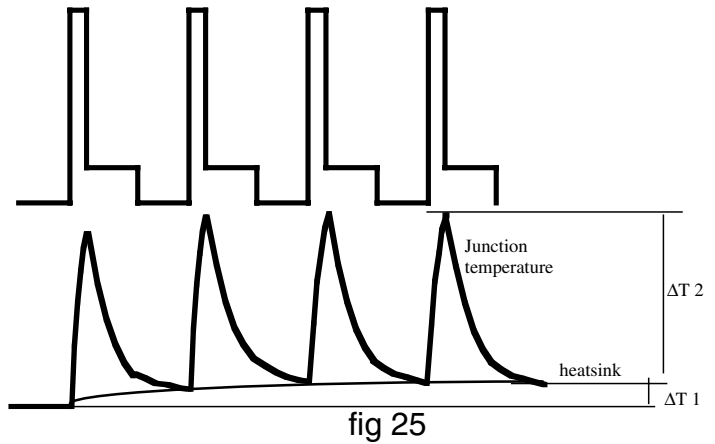
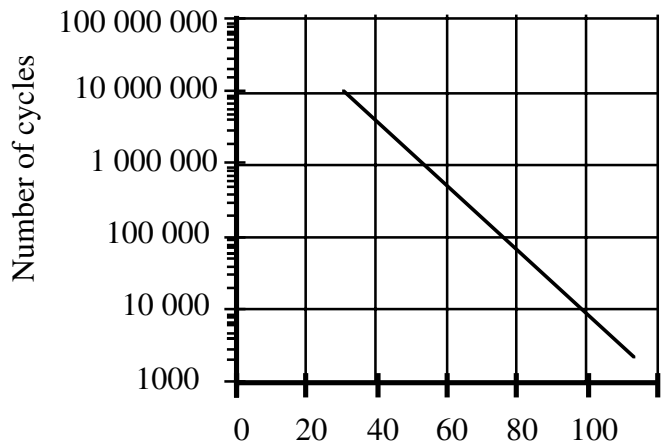

Fig 26 : Number of cycling for ΔT(K)



celduc gives the curve of the number of switching operations according to the variation in temperature (fig 26) . For the majority of applications , the variations in temperature (particularly in control mode) are low : DT <15°C with a high number of switching operations. On loads with repeated surges, an oversized relay rating is sometimes preferred. With this in mind, we provide two selection tables for our motor control relays.



ISO 9001
N° 1993/1106a

celduc[®]
r e l a i s

www.celduc.com

Rue Ampère B.P. 4 42290 SORBIERS - FRANCE E-Mail : celduc-relais@celduc.com
 Fax +33 (0) 4 77 53 85 51 Service Commercial France Tél. : +33 (0) 4 77 53 90 20
 Sales Dept.For Europe Tel. : +33 (0) 4 77 53 90 21 Sales Dept. Asia : Tél. +33 (0) 4 77 53 90 19

4 — STANDARDS AND "CE" MARKING.

All the **celduc** products are manufactured and designed in keeping with an ISO 9001 process guaranteeing optimum QUALITY.

The "CE" marking is an exclusively administrative procedure aimed at guaranteeing the free circulation of products within the European Community. It should be affixed to the product or its packaging and/or the documents enclosed with the product.

In order to have the "CE" mark, the product must be covered by one or more directives :

The following directives may apply :

- * EMC directive
- * Low voltage directive
- * Directive

The directive lays down the major requirements making reference to harmonised standards aimed at a one product = one standard objective.

The certificate of conformity therefore calls upon a standard reference system.

The standard reference system for the **celduc** products is as follows :

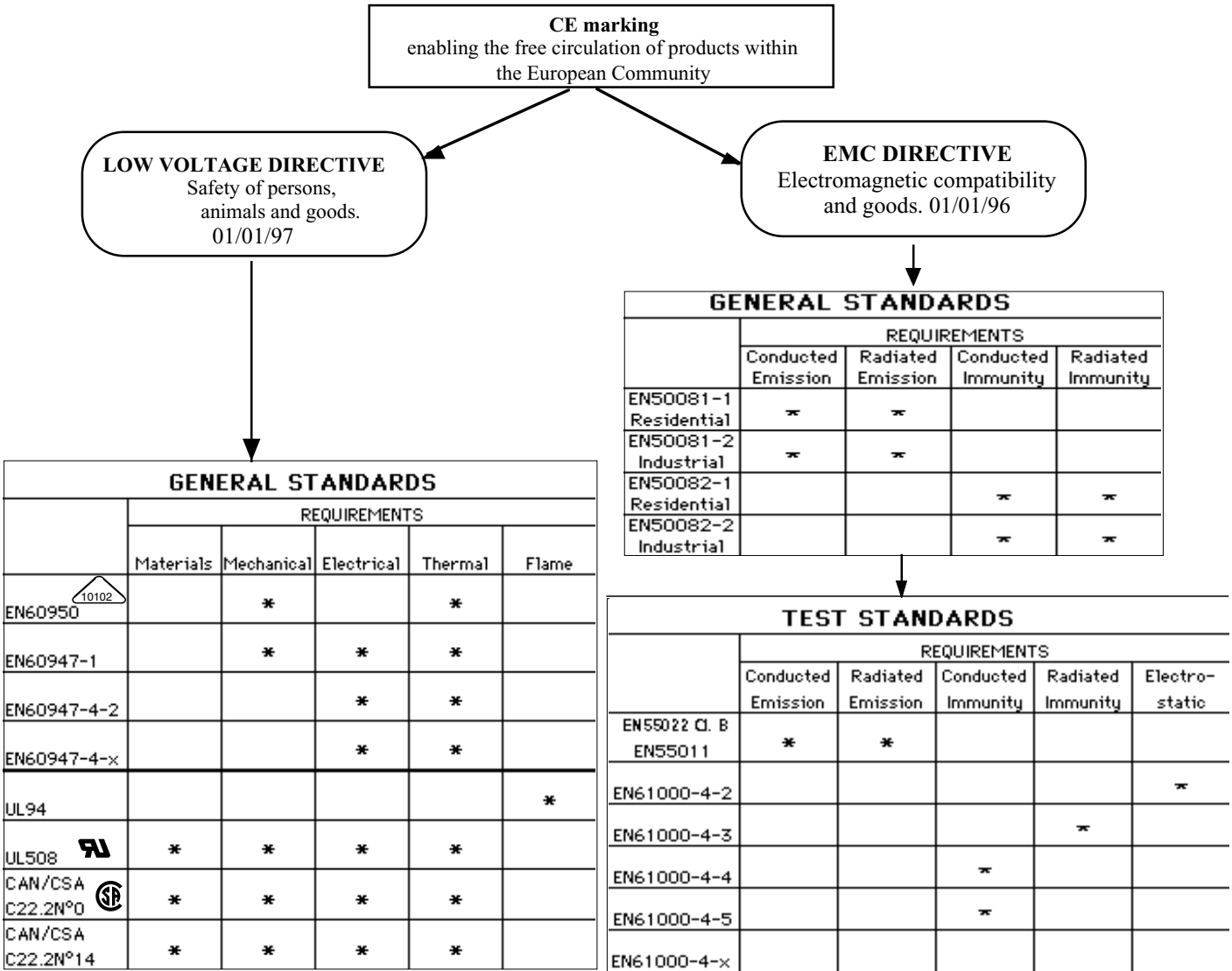

The **celduc** reference system is not limited to the European standards but all the international standards too, including UL and CSA.

With regard to "safety", the **celduc** products and specifications account for the requirements of the different standards, particularly concerning preheating :

example : maximum rise in temperature of the parts which can be touched = 50°C for permanent operation of 8 hours.

This data is important when compared to the characteristics given by the different manufacturers.



celduc[®]
r e l a i s

www.celduc.com

Rue Ampère B.P. 4 42290 SORBIERS - FRANCE E-Mail : celduc-relais@celduc.com
 Fax +33 (0) 4 77 53 85 51 Service Commercial France Tél. : +33 (0) 4 77 53 90 20
 Sales Dept.For Europe Tel. : +33 (0) 4 77 53 90 21 Sales Dept. Asia : Tél. +33 (0) 4 77 53 90 19

5 - SPECIFIC POINT ON EMC :

Reminder of the EMC standards with standards of immunity and emission tests according to the type of application :

Electromagnetic compability for celduc solid state relays :

The European directive specifies :

* A product must not be disturbed by the environment : IMMUNITY

* A product must not disturb the environment : EMISSION

The requirements depend on :

1 : the type of interference :

Conducted interference : The interference is transmitted through the wires

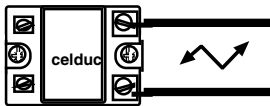

Radiated interference : The interference is transmitted in the air

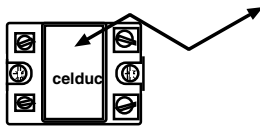

2 : the area where the product is placed

Domestic, commercial , or light industries : Installations directly connected to the public network.



INDUSTRY IN GENERAL : Installations connected to the public network through a transformer

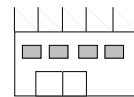

MAIN STANDARDS TO BE ADHERED TO

1- EMISSION :

Limits laid down by generic standards



EN50081-1

EN50081-2

Main standards

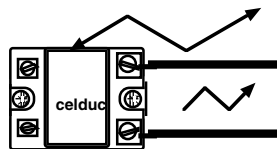

EN55022/14 class B

EN55011

2- IMMUNITY

Limits laid down by the generic standards



EN50082-1

EN50082-2

Main standards



EN61000-4-2 Electrostatic discharges

EN61000-4-3 Resistance to electromagnetic fields

EN61000-4-4 Quick bursts with dv/dt

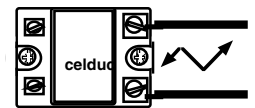

EN61000-4-5 High energy shock waves

EN61000-4-.....



ISO 9001
N° 1993/1106a

celduc[®]
r e l a i s

www.celduc.com

Rue Ampère B.P. 4
Fax +33 (0) 4 77 53 85 51

42290 SORBIERS - FRANCE

E-Mail : celduc-relais@celduc.com

Service Commercial France Tél. : +33 (0) 4 77 53 90 20

Sales Dept.For Europe Tel. : +33 (0) 4 77 53 90 21

Sales Dept. Asia : Tél. +33 (0) 4 77 53 90 19

It can be presumed that the majority of solid state relays are "components", therefore, not concerned by the EMC directive. This simply puts the problem onto our customers, so, as soon as the European directives pertaining to EMC were set up, **celduc** got down to tackling these problems. All our products have been tested in specialised laboratories and we are equipped with testing equipment capable of performing the main tests required for our products.

All our solid state relays are guaranteed with a high immunity level, very high compared to the levels required in industry in general :

EN610004-4 ;EN610004-5,.....: the levels are guaranteed in our specifications.

A standard solid state relay may have a conducted emission level greater than the level accepted by the standards. This level is linked to the type of load (mainly resistive) and the current level, **celduc** proposes conformity solutions and has developed SOFTLIFE technology products allowing for an emission level which is much lower than the levels accepted in the most severe environments : domestic applications.

It is, however necessary to point out : extract of the standard IEC60947-4-3/ EN60947-4-3

It is the responsibility of the producer of the system to ensure that the systems containing controllers and contactors meet with the requirements of all the rules and regulations applicable in terms of systems.

Solid state relays are generally designed for the device class A (Industry). The use of products in domestic environments may produce radio interference. In this case, the user may be called to use additional reduction means.

5-1) MOST FREQUENTLY USED EMC STANDARDS FOR SOLID STATE RELAYS

5-1-1- IMMUNITY :

a - EN61000-4-2 : electrostatic discharge and EN61000-4-3 : sensitivity to electromagnetic fields.

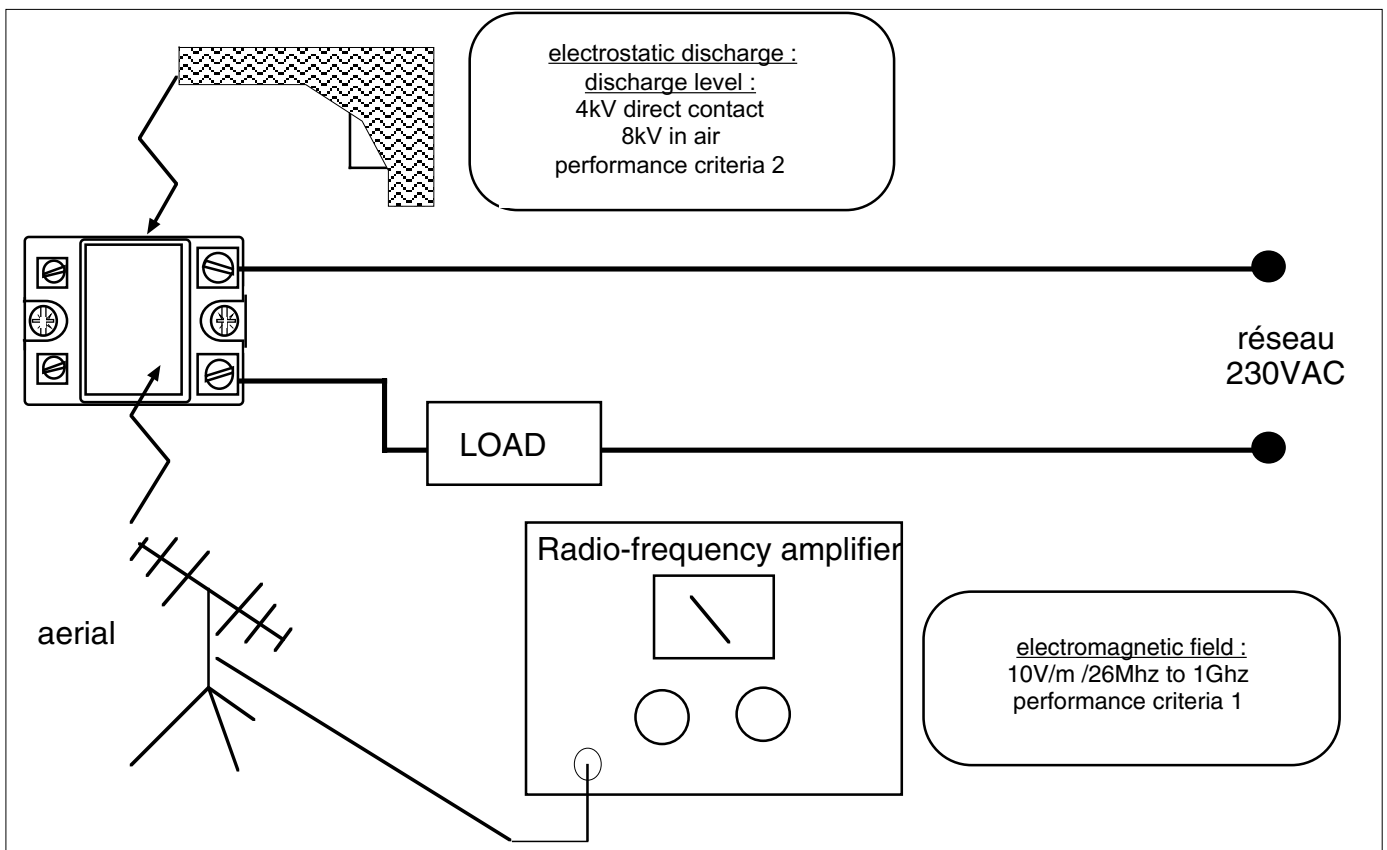

ISO 9001
N° 1993/1106a

celduc[®]
r e l a i s

www.celduc.com

Rue Ampère B.P. 4

42290 SORBIERS - FRANCE

E-Mail : celduc-relais@celduc.com

Fax +33 (0) 4 77 53 85 51

Service Commercial France Tél. : +33 (0) 4 77 53 90 20

Sales Dept.For Europe Tel. : +33 (0) 4 77 53 90 21

Sales Dept. Asia : Tél. +33 (0) 4 77 53 90 19

b- EN61000-4-4 : immunity to bursts and EN61004-5 : immunity to shock waves :

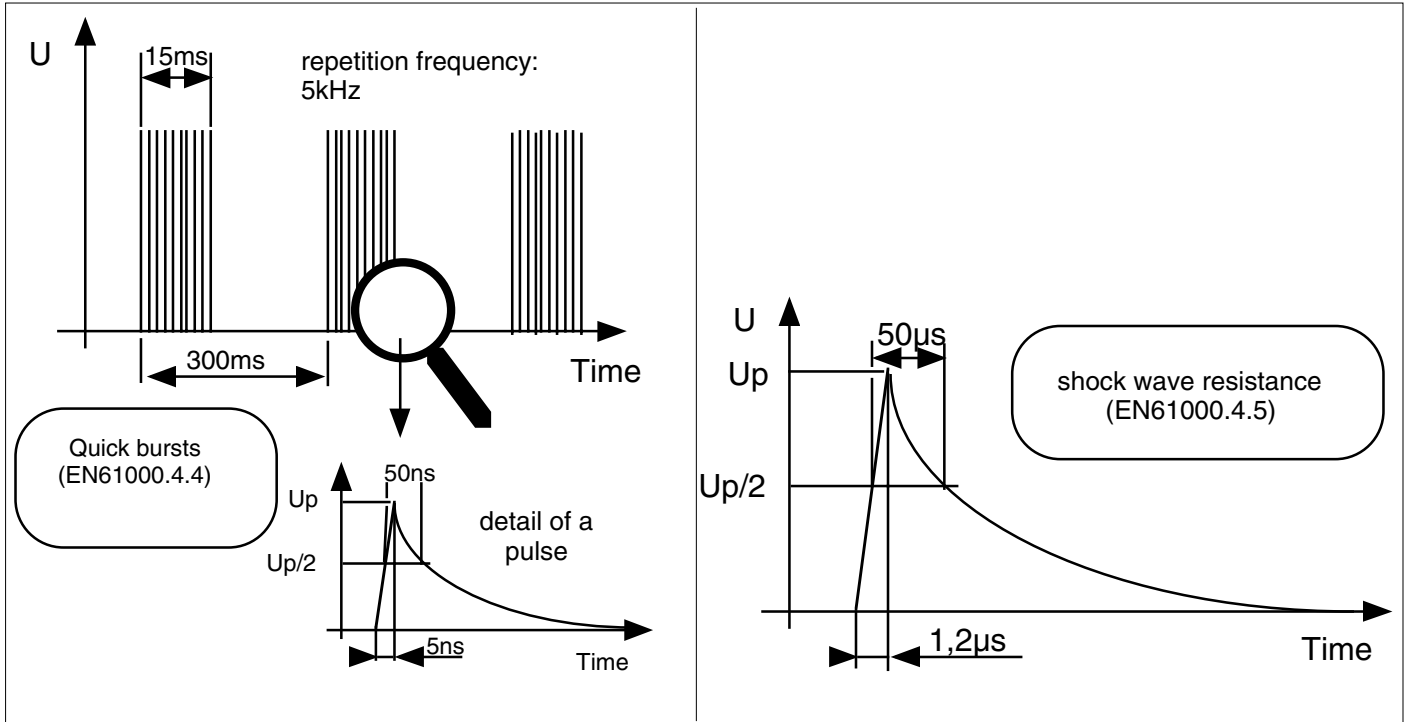

The EN61000-4-4 test corresponds to a high dv/dt test. The **celduc** relays have a very good immunity level on this test. See dv/dt/.

The EN61000-4-5 test corresponds to a high energy voltage surge. We recommend the use of varistors . The **celduc** relays are specified in terms of these 2 tests.

5-1-2- EMISSION :

All the **celduc** solid state relays have been tested in accordance with the main standards :

Electromagnetic noise conducted or radiated :

- * EN55022 for residential applications: class B
- * EN55011 for industrial applications.

For a solid state relay, the level of radition is lower than the levels accepted by the standards.

--> Conducted emission test diagram :

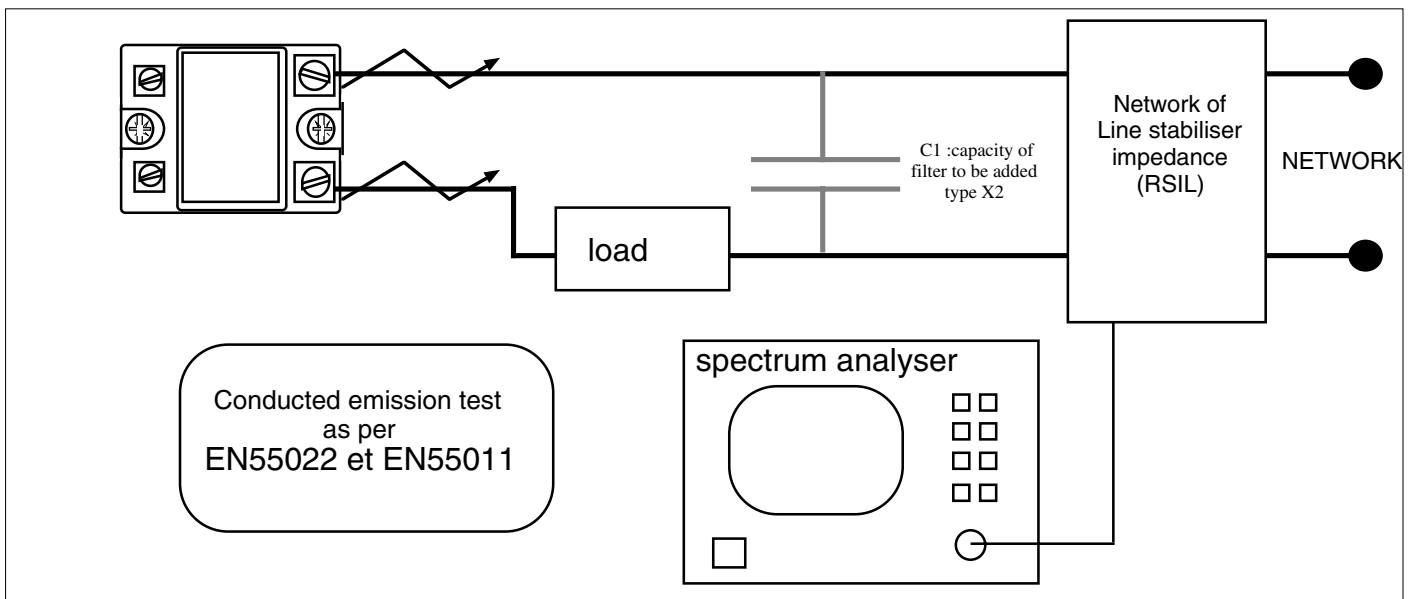

ISO 9001
N° 1993/1106a

celduc[®]
r e l a i s

www.celduc.com

Rue Ampère B.P. 4 42290 SORBIERS - FRANCE E-Mail : celduc-relais@celduc.com
 Fax +33 (0) 4 77 53 85 51 Service Commercial France Tél. : +33 (0) 4 77 53 90 20
 Sales Dept.For Europe Tel. : +33 (0) 4 77 53 90 21 Sales Dept. Asia : Tél. +33 (0) 4 77 53 90 19

Limits of the standard :

The test is performed over the frequency range of 150kHz to 30MHz .

The value measured is expressed in dB V.

The values measured must be less than the measurement template of the figure opposite.

The limit @150kHz for domestic applications is 66dB V.

The limit @150kHz for industrial applications initially at 79dB V was raised in the new EN60947-4-2 and EN60947-4-3 standards to 100dB V.

The conducted interference of a solid state relay is due to minimum operating voltages (see/3-2) .

These arcing voltages are very reduced in the celduc solid state

relays, however, the levels measured highly depend

on the load and may, in some cases, exceed

the levels permitted by the standards :

celduc recommends the following for domestic applications :

- to add a filter at the mains for resistive loads :

a simple X2 type capacitor (see test diagram below : C)

is required to overcome the problem. A parallel mounted discharge resistor is required on this capacity (rd) .

- The use of low noise " SGL " relays.

- The use of "SOFT-LIFE " technology relays particularly for "domestic" applications "when the level accepted is lower, and where the addition of a filter is problematic.

--> In the event of use of a filter : **celduc** recommends the following values on pure resistances ($\cos \varphi = 1$) :

Relay rated characteristics Caractéristiques du relais	Filtering capacitor C values - Valeurs des capacités de filtrage C	
	Class A Industrial : EN50081-2	Class B Domestic : EN50081-1
12A/230V/Charge-load:12AAC1	No - Aucun @ 100dB μ V	1 μ F / 275V / X2
25A/230V/Charge-load:25AAC1	No - Aucun @ 100dB μ V	2,2 μ F / 275V / X2
40-50A/230V/Charge-load:40-50AAC1	No - Aucun @ 100dB μ V	3,3 μ F / 275V / X2
12A/400V/Charge-load:12AAC1	No - Aucun @ 100dB μ V	1,5 μ F / 440V / X2
25A/400V/Charge-load:25AAC1	No - Aucun @ 100dB μ V	2,2 μ F / 440V / X2
40-50A/400V/Charge-load:40-50AAC1	No - Aucun @ 100dB μ V	4,7 μ F / 440V / X2
75A/400V/Charge-load:75AAC1	No - Aucun @ 100dB μ V	Consult us / Nous consulter
125A/400V/Charge-load:125AAC1	No - Aucun @ 100dB μ V	Consult us / Nous consulter

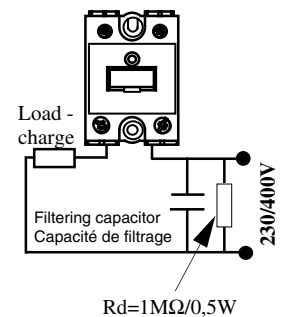

The best solution is to check the overall level of the machine. In general, motor type loads remain at a level lower than the standard in industrial applications. Please consult us.



ISO 9001
N° 1993/1106a

celduc[®]
r e l a i s

Rue Ampère B.P. 4

Fax +33 (0) 4 77 53 85 51

Sales Dept.For Europe Tel. : +33 (0) 4 77 53 90 21

42290 SORBIERS - FRANCE

Service Commercial France Tél. : +33 (0) 4 77 53 90 20

Sales Dept. Asia : Tél. +33 (0) 4 77 53 90 19

E-Mail : celduc-relais@celduc.com

www.celduc.com

